

RGMV RMMV

SERIES

TRIPPING RELAYS, MONOSTABLES
HIGH-SPEED, 4 - 8 - 12 CONTACTS

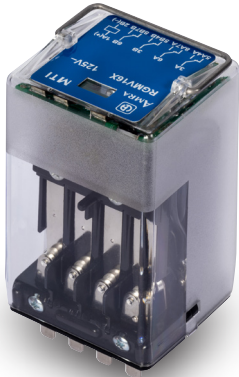

RGMV16X



RMMV12X

APPLICATIONS



OVERVIEW

- High speed operation, tripping applications
- High Burden configuration, providing immunity to capacitance discharges
- Plug-in monostable tripping relays
- High performance, compact dimensions, light weight
- Solid and rugged construction for intensive duty
- Self-cleaning knurled contacts, C/O type
- Wide contact gap for a very high breaking capacity, electrical life expectancy and insulation. Magnetic arc blow-out as standard
- Wide range of sockets
- Retaining clip for secure relay locking on socket
- Transparent cover, LED as standard and pull-out handle

DESCRIPTION

RGMV and RMMV relays are highly reliable, high performance products, suitable for applications in very harsh and disturbed environments, as per protection, command and control systems in HV electrical substations or power stations.

Range includes relays with 4, 8 and 12 contacts.

These relays are specially designed for tripping circuit breaker applications, where a contact fast-acting is essential, in order to minimize the total trip time and to avoid destruction of very expensive equipment in case of emergency situation.

The high speed operation, the valuable breaking capacity and the ability to switch also very low load (few mA) allow their use in demanding applications, where a minimum switching time is required.

- Multiplication of HV/MV protection's outputs.
- Direct acting to HV/MV primary equipment.
- Trip alarms transmission.

High insulation levels allow to limit the propagation of induced voltages, keeping separated, for functional safety purposes, different parts of the system, thus avoiding unwanted intrusiveness phenomena.

The contacts are designed to obtain remarkable performances both for high, inductive loads or very low loads. Each contact is able to switch from 10mA – 10V at new relay.

Knurled surface ensures an excellent self-cleaning effect, a lower ohmic resistance thanks to the various points of electrical contact, and will also improve the electrical life of the component.

Magnetic arc blow-out contributes in increasing breaking capacity: the relay is suitable for controlling heavy duty loads with intensive switching frequency.

“High burden” (HB) configuration provides immunity to capacitance discharge currents & power to the coil, in order to avoid relay operations in case of transients coming from extensive wiring, for example.

Construction of the relays and careful choice of the materials ensure long life and considerable ruggedness even in harsh operating environments and in presence of strong temperature fluctuations. IP40 protection is guaranteed.

STANDARD COMPLIANCE

EN 61810-1	EN 60695-2-10
EN 61810-2	EN 60529
EN 61810-7	EN 61000



MODELS	NUMBER OF CONTACTS	HIGH BURDEN ⁽¹⁾ configuration	MANUAL OPERATION	OPERATING TIME Pick-up (ms)
RGMV16X	4	—		≤ 8
RGMV17X	4	✓		
RMMV12X	8	—	✓	≤ 8
RMMV16X	8	✓	✓	
RMMV11	12	—	Option	≤ 10
RMMV17	12	✓	Option	

(1) **HIGH BURDEN Configuration:** for the operating and the specifications refer to the paragraph “**COIL DATA - HIGH BURDEN Configuration**” (see the table below).



FOR PRODUCT CODE CONFIGURATION , SEE THE “ORDERING SCHEME” TABLE



COIL DATA - STANDARD Configuration	4 C/O, 8 C/O	12 C/O
Nominal voltages at Un	DC: 24-48-110-125-220V / AC: 230V	
Consumption at Un	≤ 3.5 W	≤ 6 W
Current AVG peak at pick-up ⁽¹⁾	24Vdc < 0.8A / 20ms 48 - 110 - 125Vdc: < 0.3A / 20ms 220Vdc: < 0.1A / 20ms	24Vdc : < 1.2A / 20ms 48 - 110 - 125Vdc: < 0.5A / 20ms 220Vdc: < 0.1A / 20ms
Operating range	DC: 80 ÷ 110% Un / AC: 80 ÷ 110%	
Type of duty	Continuous	
Drop-out voltage	DC: > 5% Un	

(1) ±15%.



COIL DATA - HIGH BURDEN Configuration	4 C/O, 8 C/O	12 C/O
Nominal voltages at Un	DC: 24 - 48 - 110 - 125 - 220V	
Consumption at Un	≤ 3.5 W	≤ 6 W
Consumption at pick-up	24 - 48Vdc: < 150W (< 2ms) 110 - 125 - 220Vdc: < 300W (< 2ms)	
Immunity to capacitive discharge	10 µF @ 120% Un across the coil	
Operating range	DC: 80 ÷ 110% Un	
Type of duty	Continuous	
Drop-out voltage	DC: > 5% Un	

HIGH BURDEN CONFIGURATION provides higher security in plant control system, avoiding unwanted relay operation due to capacitive discharge currents, for example in case of an earth fault in long DC cables. A typical application is where the initiating contact may be remote from tripping relay.

HIGH BURDEN Tripping Relays is designed to withstand a “10µF capacitor discharge test”.

- Relay will not operate when a 10 µF capacitor, charged @ 120% Un, is applied across the coil.

While switching, high energy is required. After operation, high coil burden is reduced to a very low value, ensuring energy saving and avoiding overload on power supply circuit or station battery.

An electronic circuit acts as coil voltage’ regulator and controls the duration of burden.

CONTACT DATA		4 C/O, 8 C/O		12 C/O
Current	Nominal ⁽¹⁾	10A		
	Maximum pulse ⁽²⁾	20A for 1min 40A for 1s 150A for 10ms		
Example of electrical life ⁽³⁾		1A - 110Vdc - L/R 0ms - 350,000 operations 0.5A - 220Vdc - L/R 0ms - 300,000 operations		
Making capacity		30A (for 200ms) - 110Vdc - L/R 0ms: 2,000 operations		
Minimum load ⁽⁴⁾	Standard contacts	200mW (10V, 10mA)		
	Gold-plated contact ⁽⁵⁾	50mW (5V, 5mA)		
Maximum breaking voltage		250Vdc / 350Vac		
Contact material		AgCdO		
Operating time at Un (ms) ⁽⁶⁾				
	Pick-up ms	Vdc: ≤ 8	Vac: ≤ 10	Vdc: ≤ 10
	Drop-out ms	Vdc: ≤ 40	Vac: ≤ 50	Vdc: ≤ 50

(1) On all contacts simultaneously, reduction of 30%.

(2) The maximum pulse currents are those currents that can be handled, for a specified time, by the contact. They do not refer to make or break currents.

(3) For other examples, see electrical life expectancy curves.

(4) Values referred to a new product, measured in laboratory. The ability to maintain this performance over the time depends on the environmental conditions and the contact' frequency use. The use of gold plated contacts is recommended in the case of very low loads. For a correct contact use, refer to the chapter "Installation, operation and maintenance".

(5) A gold contact, if subjected to high loads, degrades superficially. In this case, the characteristics of the standard contact must be considered. This does not affect the operation of the relay.

(6) Unless specified otherwise, the operating times are expressed excluding bounces.

Only for Vac power supply: actual value may increase of max 5ms (pick-up, worst case) or 10ms (drop-out, worst case). It depends on the sinusoid front (rising or falling) while energizing or de-energizing.

INSULATION		
Insulation resistance (at 500Vdc)	between electrically independent circuits and between these circuits and ground	> 1,000 MΩ
	between open contact parts	> 1,000 MΩ
Dielectric withstanding voltage at industrial frequency	between electrically independent circuits	2 kV (1 min) - 2.2 kV (1 s)
	between open contact parts	2 kV (1 min) - 2.2 kV (1 s)
	between electrically independent circuits and ground	2 kV (1 min) - 2.2 kV (1 s)
Impulse withstand voltage (1.2/50μs - 0.5J)	between electrically independent circuits and between these circuits and ground	5 kV
	between open contact parts	3 kV

MECHANICAL SPECIFICATIONS		4 C/O	8 C/O	12 C/O
Mechanical life expectancy		10x10 ⁶ operations		
Maximum switching rate Mechanical		3,600 operations / h		
Protection rating (with relay mounted)		IP40		
Dimensions (mm) ⁽¹⁾	Mod. RGMV16X 45x50x86	45x90x100	58x188x84	
	Mod. RGMV17X 45x50x112			
Weight (g)		270	400	810

(1) Output terminals excluded.

ENVIRONMENTAL CHARACTERISTICS	
Operating temperature	-25 ÷ +55°C
Storage and shipping temperature	-40 ÷ +85°C
Relative humidity	Standard: 75% UR - Tropicalized: 95% UR
Fire behaviour	V0

STANDARDS AND REFERENCE VALUES	
EN 61810-1, EN 61810-2, EN 61810-7	Electromechanical elementary relays
EN 60695-2-10	Fire behaviour
EN 60529	Degree of protection provided by enclosures
EN 61000	Electromagnetic compatibility



CONFIGURATIONS - OPTIONS

TROPICALIZATION	Surface treatment of the coil with protective coating for use with RH 95%.
GOLD PLATING	Surface treatment of the contacts, with gold-cobalt alloy $\geq 5\mu$ (since 2023, May). This treatment ensures long-term ability of the contact to conduct lower currents.
LEVER FOR MANUAL OPERATION	Allow to manual operating the relay (available only for the RMMV11 and RMMV17 models)
HIGH BURDEN (HB)	The HB "High Burden" Configuration provide immunity to capacitance discharge currents & power to the coil, in order to avoid relay operations, for example in case of transients coming from extensive wiring.



ORDERING SCHEME

PRODUCT CODE	CONFIGURATION A	CONFIGURATION B	TYPE OF POWER SUPPLY	NOMINAL VOLTAGE (V)	FINISH ⁽¹⁾
RGMV	1: Standard 4: Gold Plating	6X: 4 contacts 7X: 4 contacts with HB	C: Vdc A: Vac	Vdc 024 - 048 - 110 - 125 Vac 230 ⁽²⁾	T: Tropicalized coil (lever for manual operation not available)
RMMV	1: Standard 4: Gold Plating	2X: 8 contacts 6X: 8 contacts with HB	C: Vdc A: Vac	Vdc 024 - 048 - 110 - 125 Vac 230 ⁽²⁾	T: Tropicalized coil (lever for manual operation always included)
RMMV	1: Standard 4: Gold Plating	1: 12 contacts 7: 12 contacts with HB	C: Vdc A: Vac	Vdc 024 - 048 - 110 - 125 Vac 230 ⁽²⁾	T: Tropicalized coil M: Lever for manual operation

(1) Optional value. Possible the multiple choice (Ex. TM)

(2) NOT AVAILABLE FOR HB Configuration

Example

RGMV	1	7X	C	024	
RGMV17X-C024= Relay with standard contacts, 4 C/O, High Burden configuration, 24Vdc coil					
RMMV	4	1	A	230	M
RMMV41-A230/M= Relay with gold plating, 12 C/O, 230Vac coil, lever for manual operation					



WIRING DIAGRAM

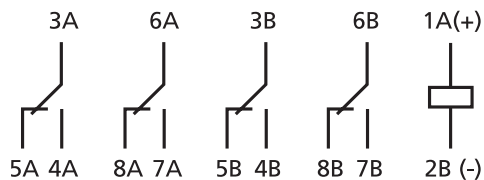

RGMV16X - RGMV17X

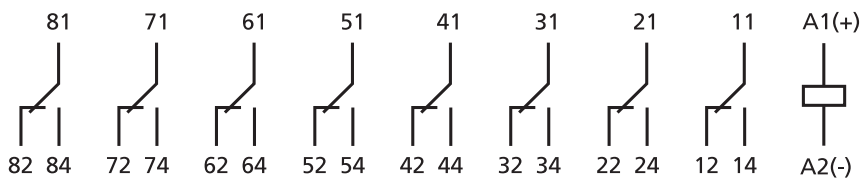

RMMV12X - RMMV16X

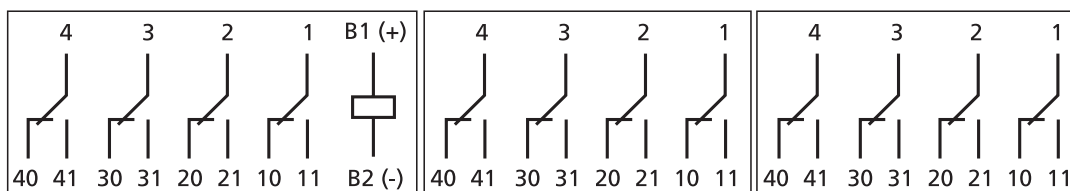

RMMV11 - RMMV17

DIMENSIONS

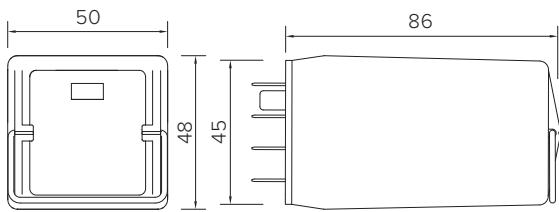

RGMV16X

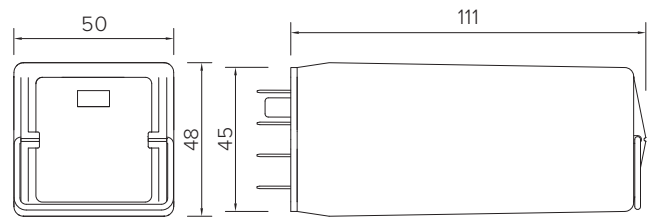

RGMV17X

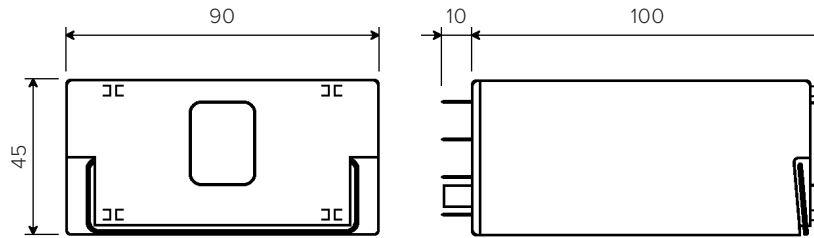

RMMV12X - RMMV16X

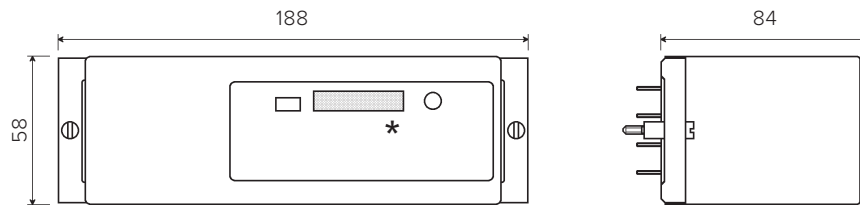

RMMV11 - RMMV17

ELECTRICAL LIFE EXPECTANCY

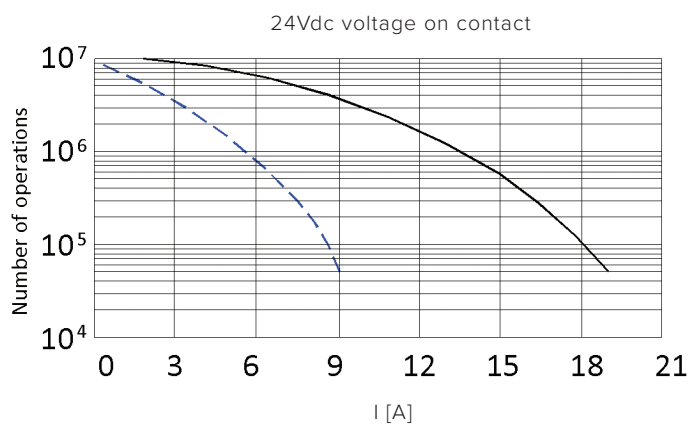

LEGEND

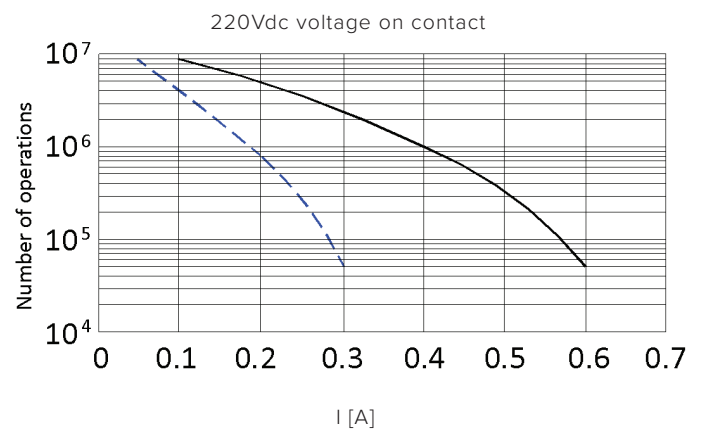
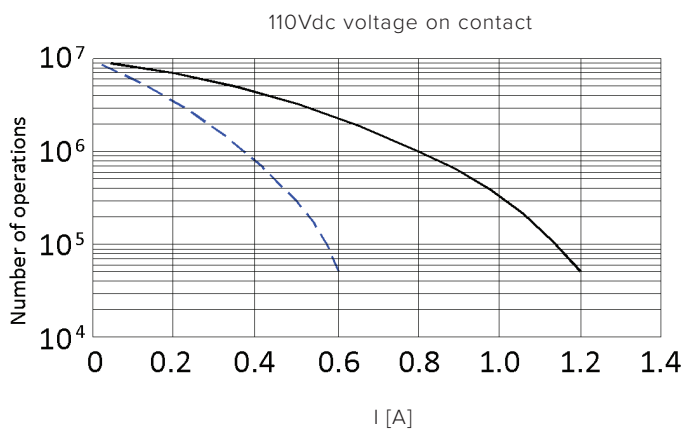
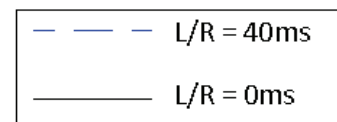



SOCKETS		RGMV.x6X - RGMV.x7X	RMMVx2X - RMMVx6X	RMMVx1 - RMMVx7
Type of installation	Type of outputs	Model		
Wall or DIN H35 rail mounting	Screw	48BIP20-I DIN	96IP20-I DIN	PAVM481
	Spring clamp	PAIR160	PAIR320	-
Flush mounting	Screw	-	-	PRVM481
	Spring clamp	PRIR160	PRIR320	-
	Double faston (4.8 x 0.8 mm)	ADF2	ADF4	PRDM481



RETAINING CLIPS		RGMV.x6X - RGMV.x7X	RMMVx2X - RMMVx6X	RMMVx1 - RMMVx7
Socket models	Model			
48BIP20-I DIN, 96IP20-I DIN	RG48	RMC48 ⁽¹⁾	-	
PAIR160, PAIR320			-	
ADF2, ADF4			-	
PAVM481, PRVM481, PRDM481	-	-	Fixing with integrated screws	

(1) 2 pieces for each relay



INSTALLATION, OPERATION AND MAINTENANCE

Installation

Before installing the relay on a wired socket, disconnect the power supply.

The preferential mounting position is on the wall, with the relay positioned horizontally in the “reading orienting” of marking so that the label is readable in the correct sense.

Spacing: no relay spacing is required.

If a relay is used in the “less favorable” conditions that occur with “simultaneously”:

- Power supply: the maximum allowed, permanently
- Ambient temperature: the maximum allowed, permanently
- Current on the contacts: the maximum allowed, permanently
- Number of contacts used: 100%

It is strongly recommended to space relay at least 5 mm horizontally and 20 mm vertically, to allow for proper upward heat' dissipation and increase the longevity of the component.

Actually, relays could be used in less severe conditions. In this case, the distance between adjacent relays can be reduced or abolished. A correct interpretation of the use' conditions allows the optimization of the available spaces. Contact AMRA for more information.

To increase relay' longevity, we recommend mounting relays intended for “continuous use” (permanent power supply), alternating them with relays intended for less frequent use.

For a safe use, the retaining clip is recommended. 12 C/O relay is equipped by fixing screws.

For further details please read the paper document supplied with the relays and named “Instructions for installation of multi-pole relays”.

Operation

Before use: if relay is not used, for example after long storage periods, contact resistance may increase due to a natural and slight oxidation or polluting deposits.

In order to restore the optimal conductivity and for standard contacts (**NOT gold plated**) it is recommended to switch several time a load of at least 110Vdc - 100mA or 24Vdc - 2A. The contacts will be "cleaned" thanks to the electric arc generated during the current interruption and the mechanical self-cleaning action.

The common contact rubs against the fixed poles (NO and NC contacts) both when opening and when closing, which ensures a self-cleaning action.

An increase in contacts' resistance, in most cases, does not represent a problem. Many factors contribute to the correct use of contact and consequently to the relay' long-term reliability:

- **Load:** the current switching generates an electric arc with cleaning effects. For proper electrical cleaning and performance keeping we recommend:
 - Standard contacts: Minimum current = 20mA (20V)
 - Gold plated contacts: Minimum current = 10mA (20V)
- **Operating frequency:** relays are components that can operate with a wide range of switching frequency. High frequency operation also allows a continuous cleaning effect by "sliding" (mechanical cleaning). In case of low frequency operation (for example few time a day), we advise:
 - Use of contact with currents twice compared to those indicated.
 - For currents lower than 10mA, use gold plated contacts and connect 2 contacts in parallel, in order to reduce the equivalent contact resistance
- **Pollution:** the presence of pollution can cause impurities on contact surface. Electric charges attract organic molecules and impurities that are deposited on the contact surface. Electrical and mechanical cleaning, respectively, burn and remove such impurities. In pollution presence, the minimum recommended currents must be respected. In extreme cases, provide double the cleaning current.

While a contact open high loads, impurities develop inside the relay due to the formation and interruption of the electric arc. These impurities are greater the higher the load and the more frequent the switching operation. These impurities could deposit on the adjacent contacts and alter the initial conductivity characteristics. If all contacts are used with similar loads, this is not a problem. Please, contact AMRA for further informations.

Condensation is possible inside the relay when energized and the outside ambient temperature is cold; this is quite normal and does not affect the operation of the relay. Plastic materials of relay do not possess hygroscopic properties.

Maintenance

No maintenance is required.

In case of normal relay wear (reaching the end of electrical or mechanical life), the relay cannot be restored and must be replaced.

To check the component, relay removal must be carried out with slight lateral movements. An "up and down" movement can cause terminals damage.

For RMMV11 / RMMV17 removal, please read the product instructions.

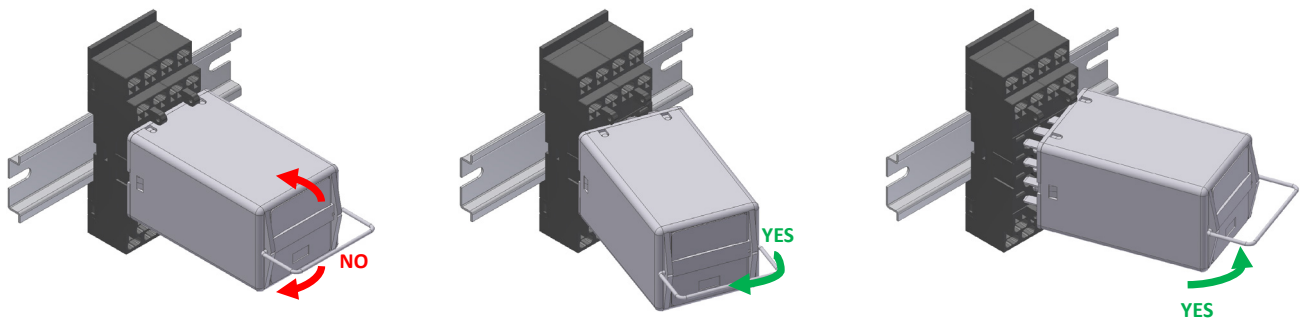

Often the malfunctions are caused by power supply with inverted polarity, by external events or by use with loads exceeding the contact performance.

In case of suspected malfunction, energize relay and observe if mechanical operation of contacts / relay mechanism is performed. Pay attention to the power supply polarity, if relay is equipped with polarized components (example: diode, led).

- In case of expected operation, clean the contacts (see paragraph "OPERATION") and check if the circuit load ranges within the contact performance. If necessary, replace with relays with gold contacts. Note: the electrical continuity of contacts must be checked with adequate current.
- If it does not work, we recommend to use a relay of the same model and configuration.

If an investigation by AMRA is required, pull-out the relay from the socket, don't remove the cap, avoid any other manipulation and contact us. You will be asked for the following data: environmental conditions, power supply, switching frequency, contact load, number of operations performed.

The fault can be described through the "TECHNICAL SUPPORT" section of the website www.amra-chauvin-arnoux.it.

In any case, the relay cannot be repaired by the user.

Storage

Storage conditions must guarantee the environmental conditions (temperature, humidity and pollution) required for the product conservation, in order to avoid deterioration.

The product must be stored in an environment sheltered from atmospheric agents and not polluted, with an ambient temperature between -40 and +85°C with max 75% RH. Humidity can reach peaks of 95%. In any case, there must be no condensation. Before use, please read carefully "OPERATION" section.